



DB20-H

All-in-one Phone Station

USER MANUAL

Directory

1. Introduction	3
2. In the Box	3
3. Instructions	4
3.1. DB20-H All-in-one phone station	4
4. How to Charge	5
4.1. Power ON	5
4.2. Wireless phone charge	5
5. How to Use the Wireless Handset	6
5.1. Handset power on	6
5.2. Handset charge	6
5.3. Handset connect to the base	7
5.4. Handset LED indicator	7
6. How to Use	8
6.1. USB Connection for PC	8
6.2. Bluetooth Connect	8
6.3. Manual reconnect when not auto-reconnect	8
6.4. Reset List	9
6.5. Call Control	9
6.6. Mute	9
6.7. Volume Adjustment	10
6.8. Base LED indicator	10
7. Document Center	11
8. Safe Usage Guidelines	11

1. Introduction

DB20-H is a neat all-in-one phone station with seamless communication for smartphone and PC.

Free the desk space

Softphone/UC Companion

Speakerphone and wireless handset

Phone charger

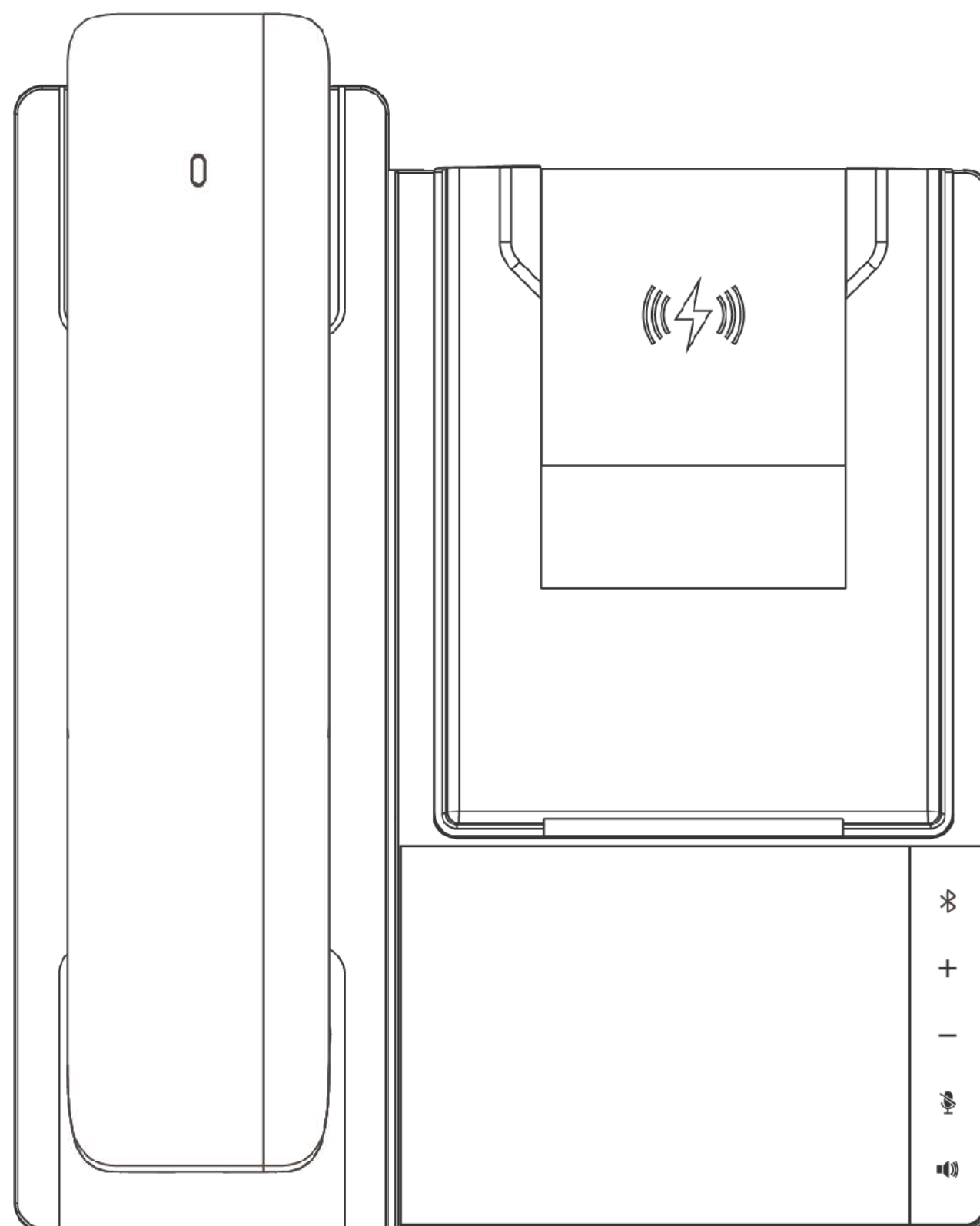

Features

- Free the desk space with all-in-one design
- Calling seamlessly among softphone*/UC and phone calls
- Speakerphone and wireless handset for smartphone and PC
- Wireless phone charging** station

2. In the Box

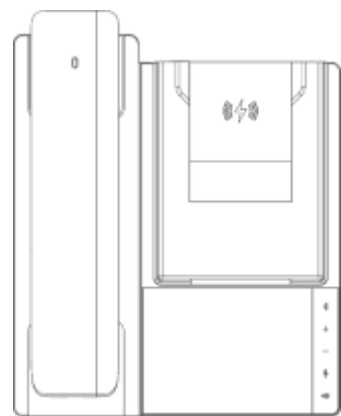

All-in-one Phone Station

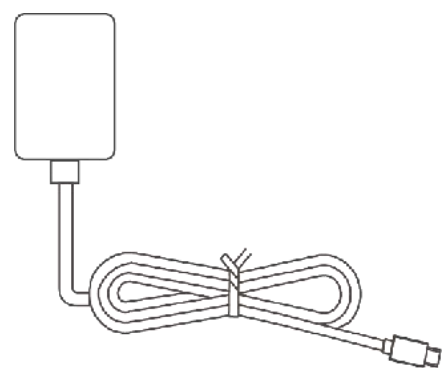

Power Adapter

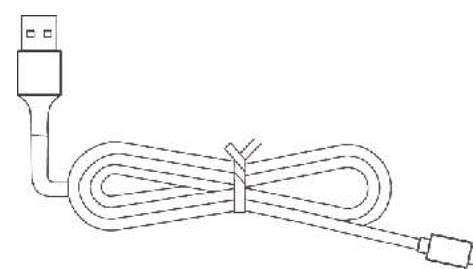

USB Cable

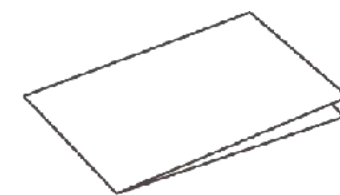

Quick Start Guide

3. Instructions

3.1. DB20-H All-in-one phone station

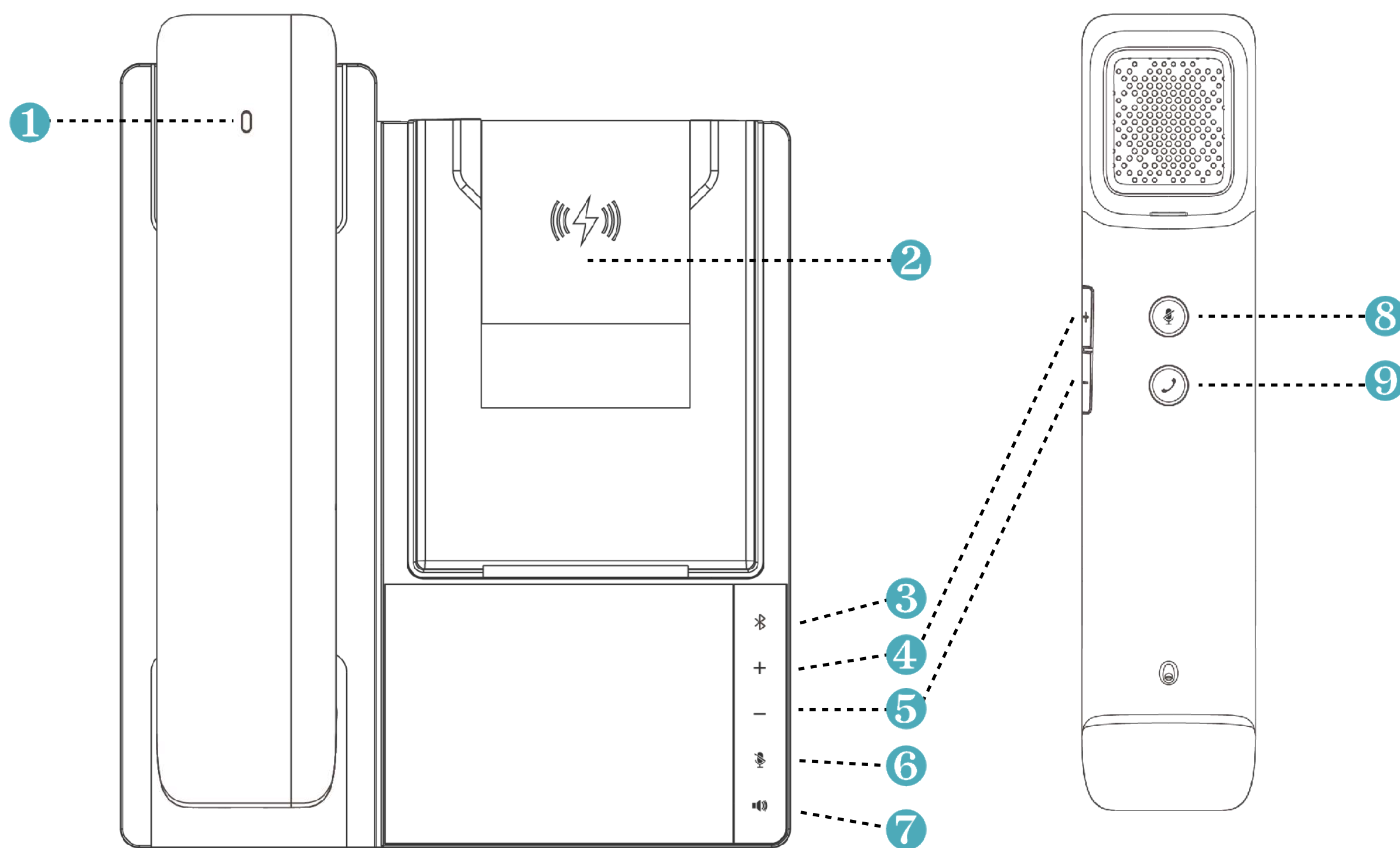

- | | | |
|--------------------------|---------------|-----------------------|
| ① Handset LED | ④ Volume up | ⑦ Speakerphone button |
| ② Wireless phone charger | ⑤ Volume down | ⑧ Mute button |
| ③ Bluetooth button | ⑥ Mute button | ⑨ Call button |

4. How to Charge

4.1. Power ON

Connect the power adapter* to the Power port on the rear of DB20-H to power ON.

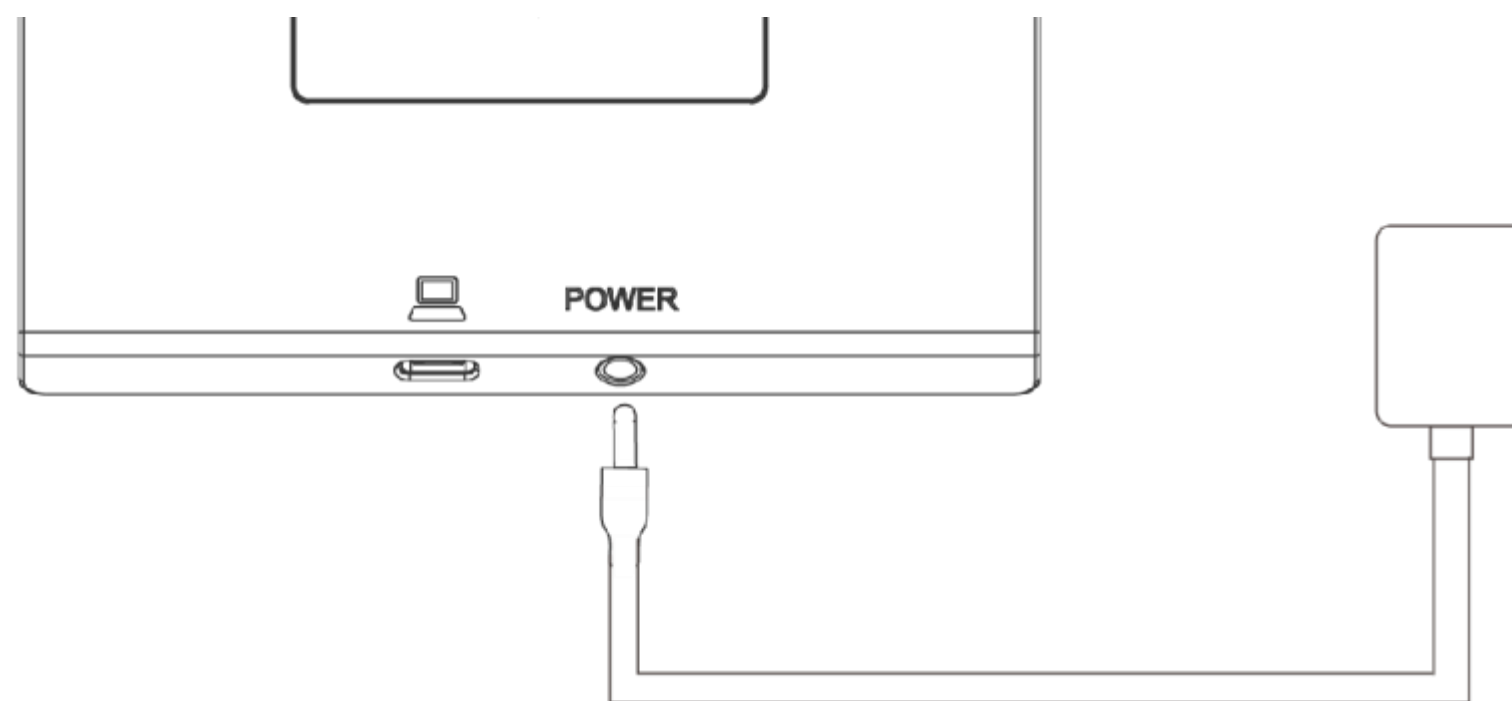

* Excessive voltage may cause damage to the product. Using a power supply that exceeds the specified voltage can damage the device or pose other potential risks. To ensure the safety and proper operation of the device, be sure to use the power specifications provided in the packaging or an equivalent power supply.

4.2. Wireless phone charge

To charge your phone wirelessly, simply place it in the wireless phone charger and make sure it is aligned with the charging zone.

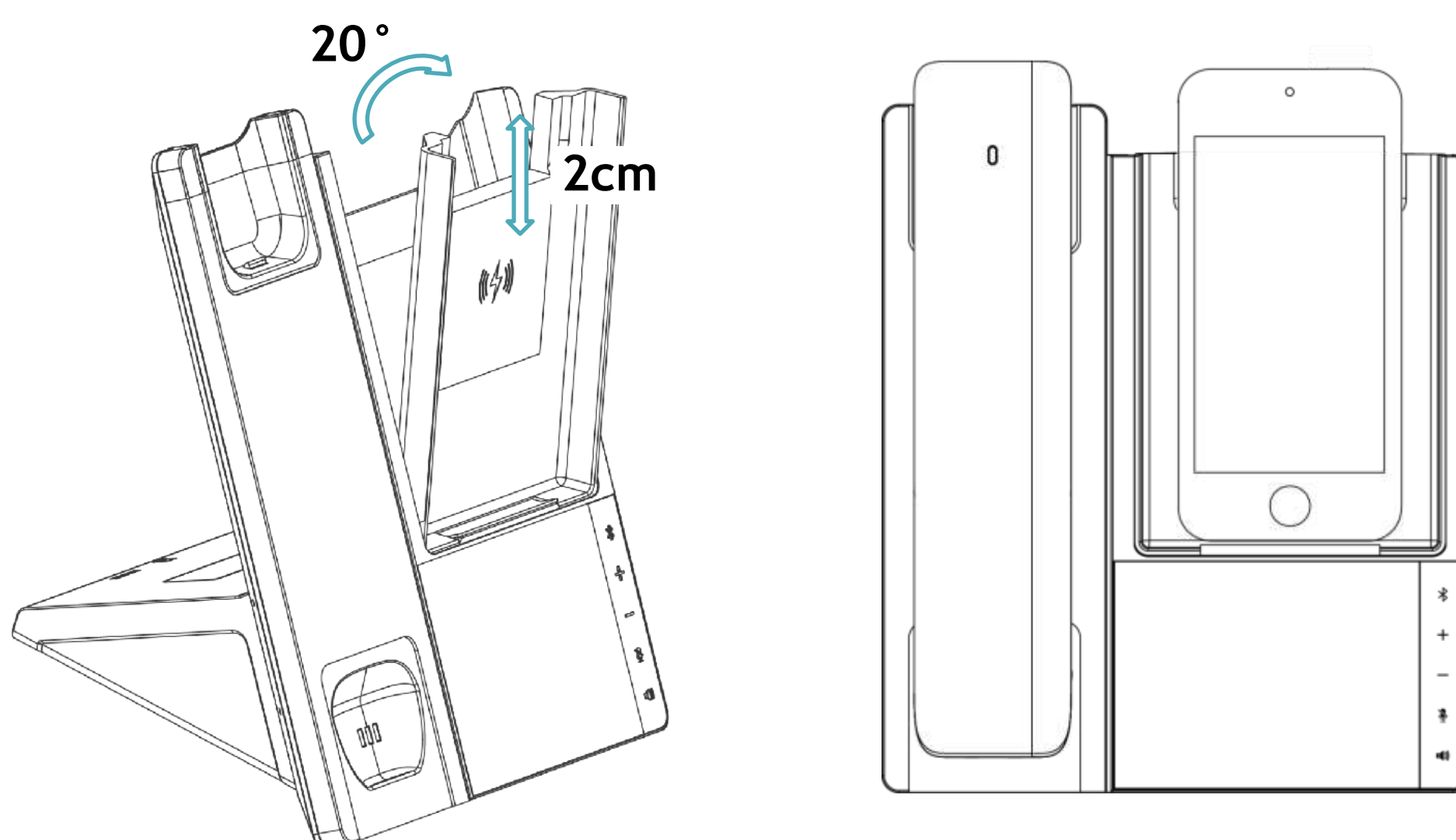

Tips

Additionally, you can the phone charger's position vertically for 2cm to accommodate different phone sizes, and horizontally adjusted by 20° to adapt to various viewing angles. This enhances flexibility and visual comfort during use.

5. How to Use the Wireless Handset

5.1. Handset power ON

To power ON the handset, press and hold the call button for 3s.

Tips

The wireless handset has a built-in battery, so it is important to ensure that the handset is powered on during use.

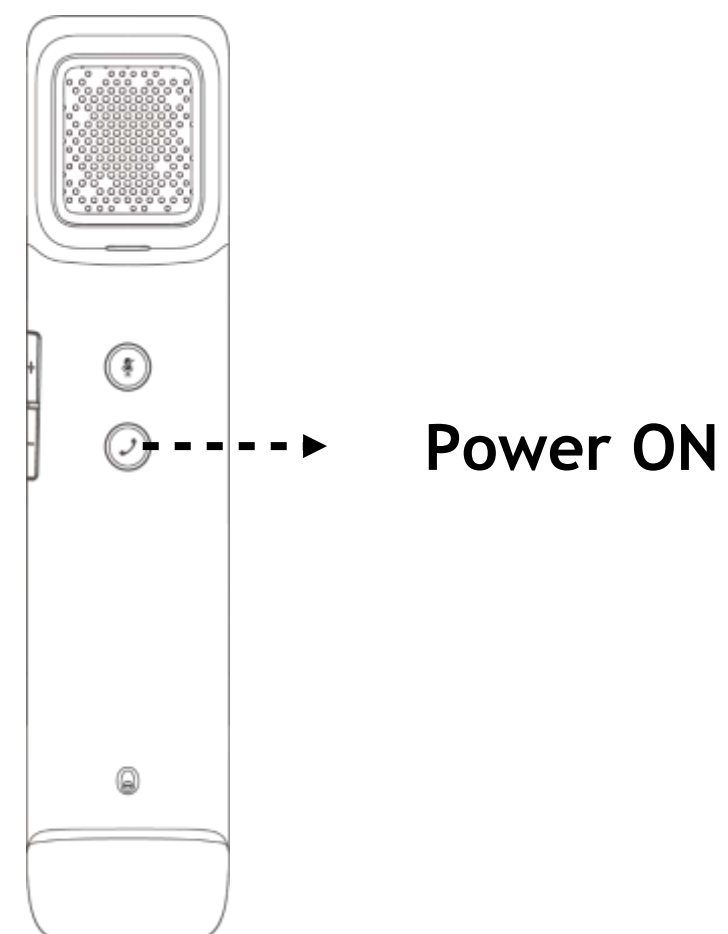

5.2. Handset charge

Place the handset back to the dock, ensure that the contact points are aligned and connected. The handset will start charging automatically.

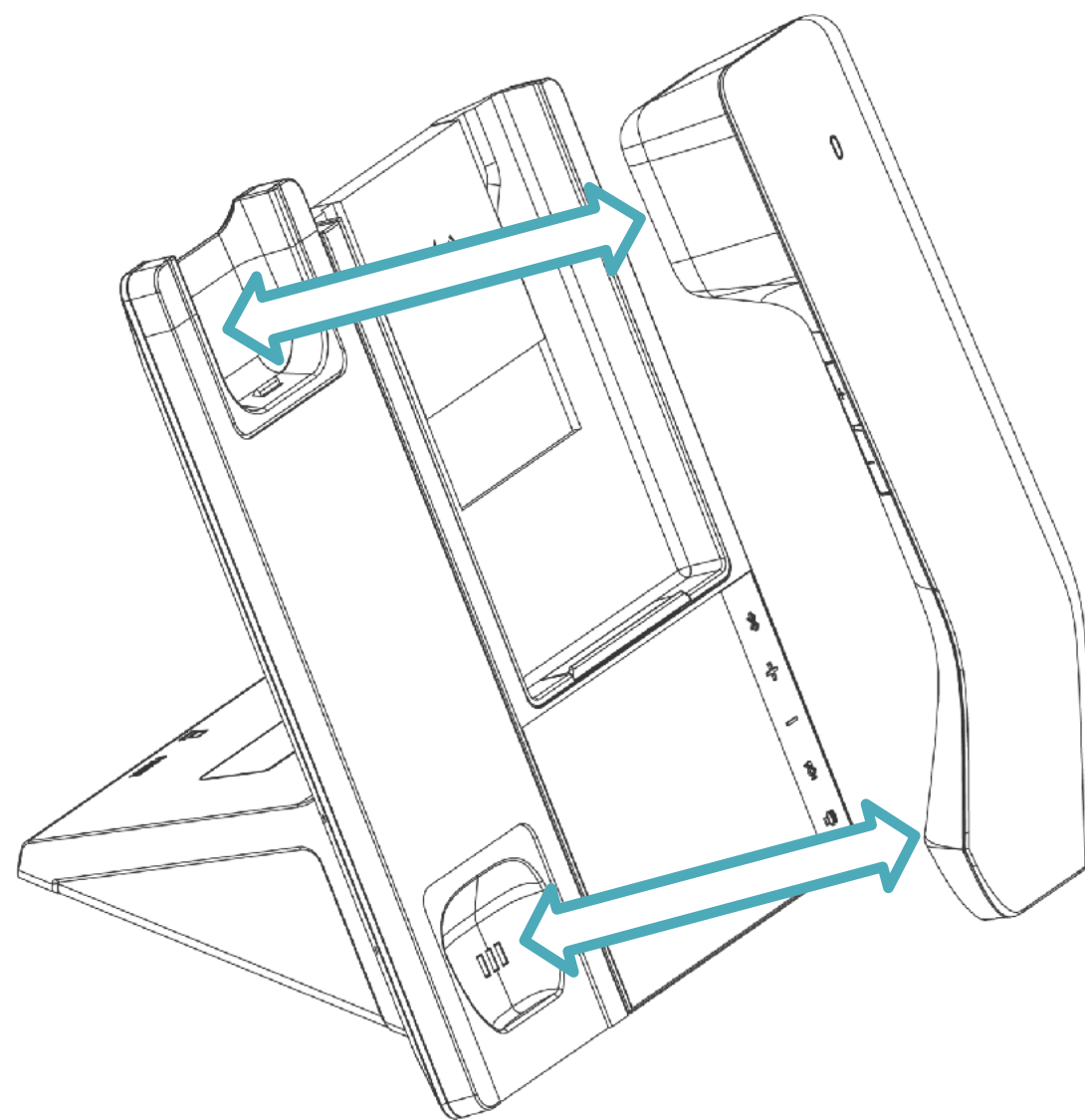

Tips

When the handset battery level drops to low level, there will be LED reminder and an audio alert for low battery. Subsequently, a low battery reminder will be prompted every 5 minutes.

5.3. Handset connect to the base

Auto-connection:

The handset automatically pairs and connects when placed in the handset slot.

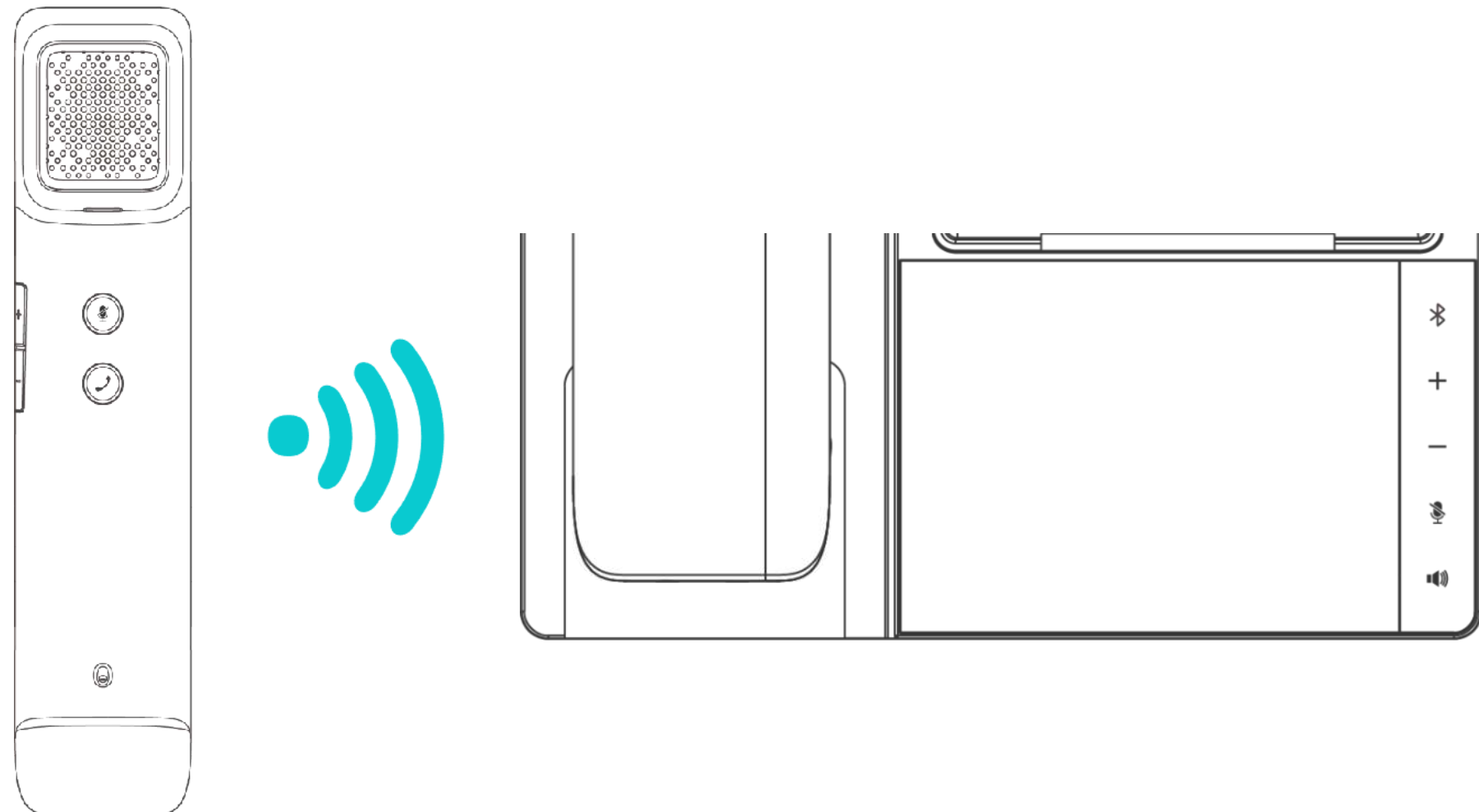

Tips

Find the handset:

If the base is in idle state and the handset is not placed on the base, tap the Bluetooth button twice to make the handset emit a continuous short beep. Double tap the base's Bluetooth button to turn off the short beep.

5.4 Handset LED Indicator

Event	Busy light	
Power ON	Solid Green 3s	
Power OFF	Flashing Green 3 times	
Incoming call	Flashing Green	
Mute	Solid Red	
Battery below 10%	Flashing Red	
Fully charged	Solid Green	
Not connected to the base	Flashing Blue 5s	
Searching for base	Flashing Blue and Green	
Handset connected with base	Solid Blue 3s	

6. How to use

6.1. USB Connection for PC

After connecting the base to the computer via a USB cable, the speakerphone button's green light will stay ON for 3 seconds and OFF afterward.

* The USB cable doesn't supply power but data transmission only.

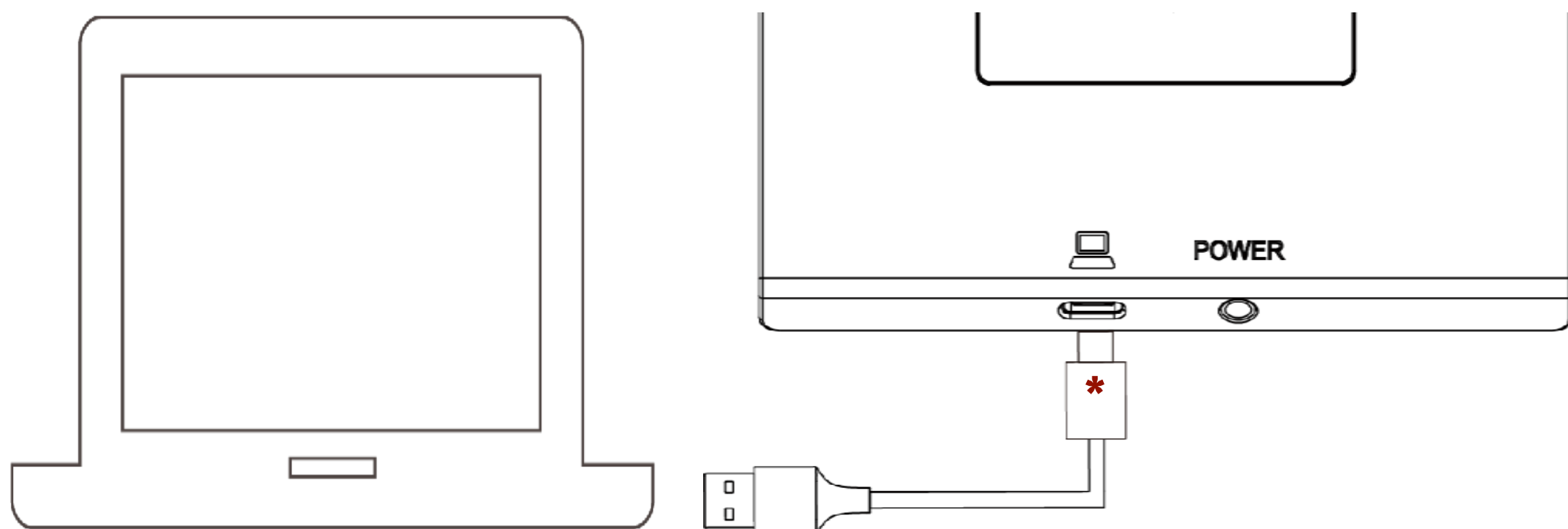

6.2. Bluetooth Connect

Press and hold the Bluetooth button for 1s to enter pairing mode. From the list of Bluetooth devices, select "DB20-H" to pair it.

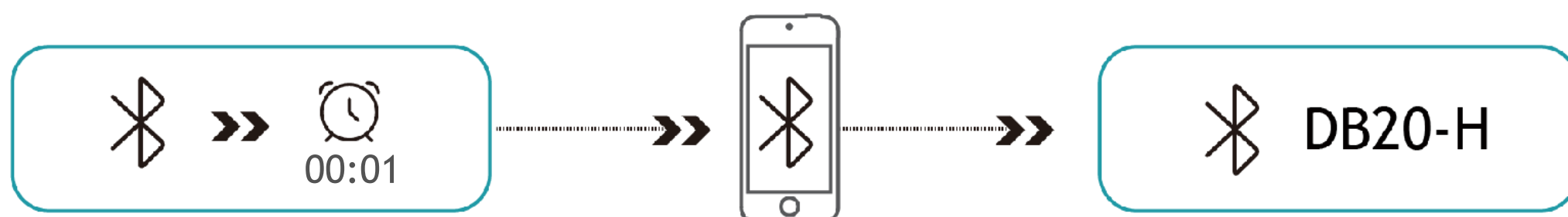

Tap the Bluetooth button in pairing mode, the pairing will be cancelled.

6.3. Manual reconnect when not auto-reconnect



In order to reconnect when you move out of the Bluetooth range and then return, but the base does not automatically re-establish the connection, you may simply tap the Bluetooth button, which will prompt the base to search for the most recently connected device and automatically reconnect with it.

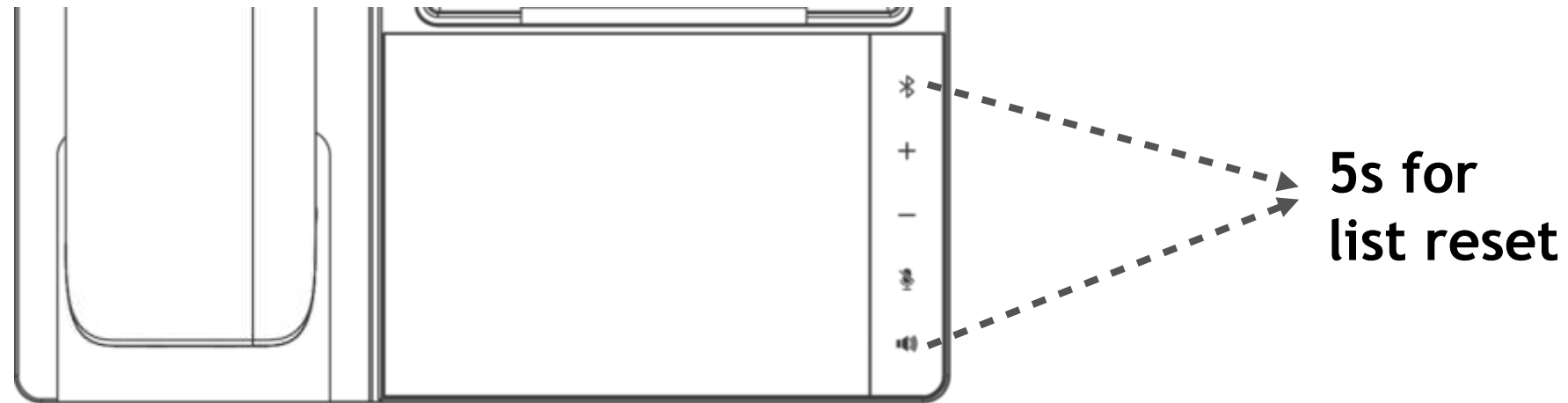

6.4. Reset List

Press and hold the speakerphone button and Bluetooth button for 5 seconds, then release them to clear the Bluetooth pairing list.

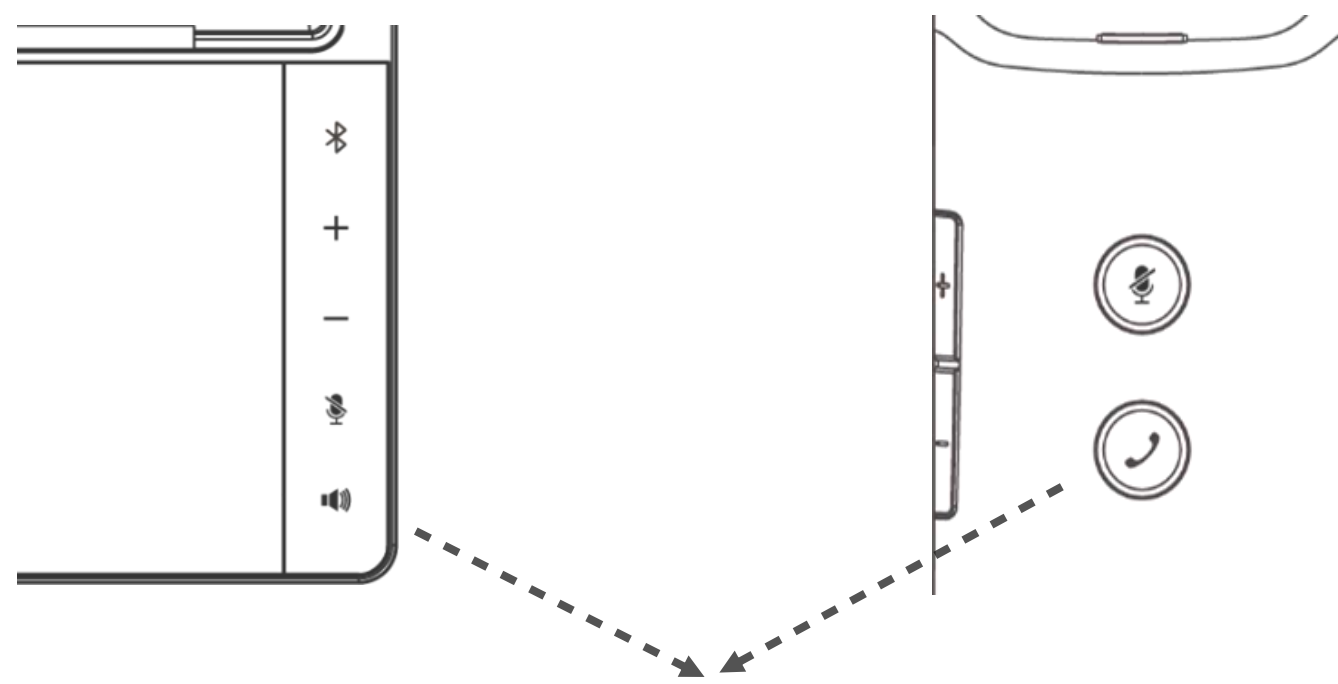

6.5. Call Control



 <p>Answer call</p> <ul style="list-style-type: none"> • Press when call incoming • Pick up the handset 	 <p>Hang up call</p> <ul style="list-style-type: none"> • Press • Put handset back in the handset slot 	 <p>Reject call</p> <ul style="list-style-type: none"> • Double press when call incoming 	 <p>Redial</p> <ul style="list-style-type: none"> • Double press when idle
---	--	---	---

6.6. Mute

Press the Mute button on the speaker or handset. Press it again to unmute. When the Mute button is pressed while the DB20-H is idle, the incoming ring will be Muted.

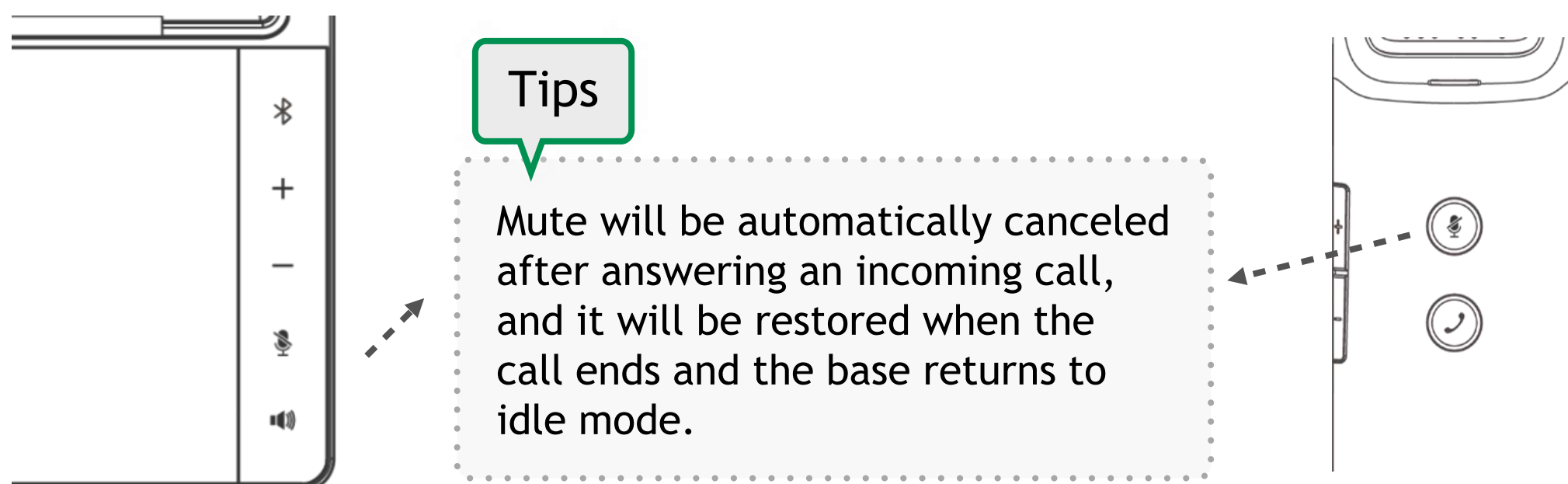





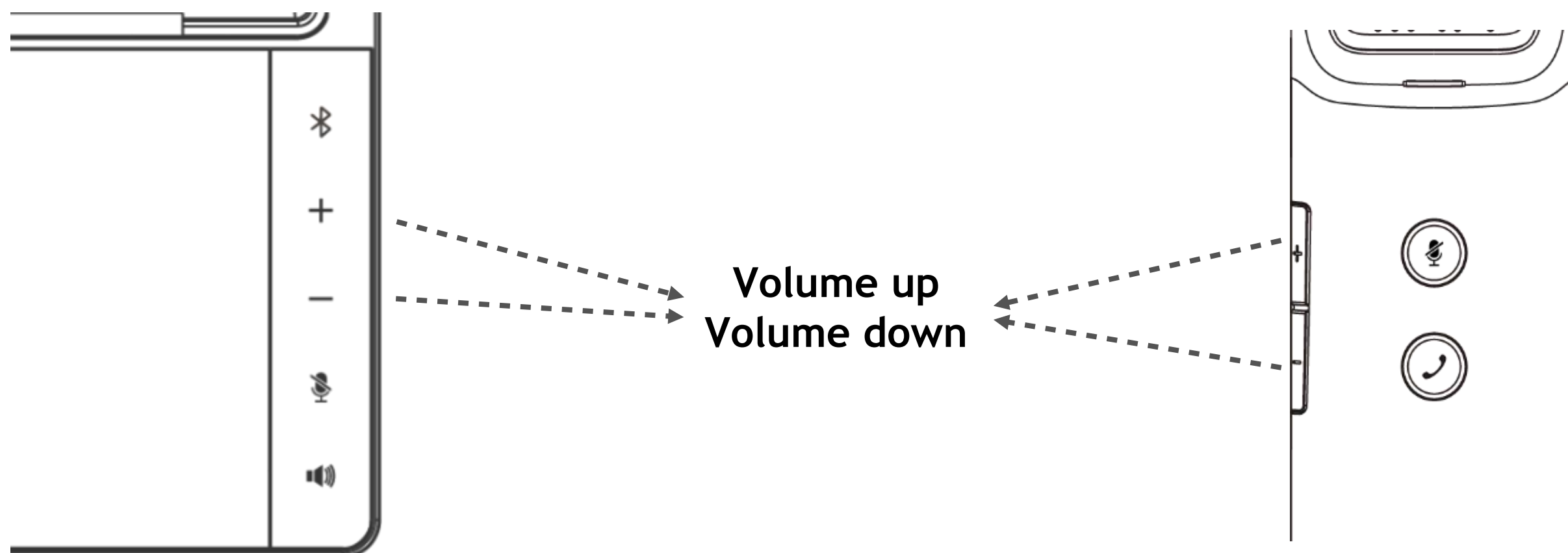

6.7. Volume adjustment

Press the Volume up/down button on base or handset.



6.8. Base LED Indicator

Event	Call button	Bluetooth button	Mute button
Power ON	Solid Green 3s 	/	/
Incoming call	Flashing Green 	/	/
Mute	/	/	Solid Red 
Pairing	/	Flashing Blue 	/
Connected	/	Solid Blue 	/
Pairing failed	/	Flashing Blue 3s 	/
Reset list	/	Flashing Blue 	/

7. Document Center



Following documents can be downloaded from our document center:
Datasheet, Quick Start Guide, User manual, FAQ



<https://fanvil.com/service/doc/file/linkvils/linkvil/db20-h/index.html>

8. Safe Usage Guidelines

- Do not open modify the product except for internal parts removal and replacement.
- Do not disassemble or attempt to service the product.
- This Product is safe under normal and reasonably foreseeable misuse operating conditions.
- If product is operating improperly, contact the authorized reseller.
- Product must be returned to the authorized reseller for any service or repair.
- This is not a Children's Product and is not intended for use by children under 14 years old.

About FANVIL

FANVIL Technology Co., Ltd. (FANVIL) is a leading global provider of A&V-IoT (Audio& Video- IoT) devices with three R&D centers in Beijing, Shenzhen, and Suzhou, China, and three factories in Huizhou and Shangrao, China, and Vietnam. FANVIL has focused on Unified Communication technology innovation for more than 20 years and provides SIP phones and SIP security industrial products in the global market. As the pioneer in applying standardized network communication technology and Audio & Video technologies to build A&V IoT, we are boosting the digital transformation for multiple industries.

About LINKVIL

As the sub-brand of FANVIL, LINKVIL will focus on the research and development of A&V-IoT wireless communication products. Based on Audio & Video -IoT, LINKVIL helps to achieve the full connection of wireless communication systems. LINKVIL builds a wireless communication Eco-system for multi-scenarios to help accelerate digital transformation.

Copyright

Copyright © 2024 FANVIL Technology Co., Ltd.

All rights reserved. No parts of this publication may be reproduced or transmitted in any form or by any means, electronic or mechanical, photocopying, recording, or otherwise, for any purpose, without the express written permission of FANVIL Technology Co., Ltd.

More Information

The above specifications may be updated in the future without prior notice. All hardware/software/physical features should be based on the final shipped products. For more information, please visit: www.fanvil.com

Compliance



FANVIL | LINKVIL

FANVIL Technology Co., Ltd.

Web: www.fanvil.com

Add: 10/F Block A, Dualshine Global Science Innovation Center, Honglang North 2nd Road, Bao'an District, Shenzhen, China

Copyright © 2024 Fanvil Technology Co., Ltd.